















Ladegew 15 000kg Bodenfl 21,3 m²
Tragl 17 500kg LbP 9,30 m

Gew d W 8720 kg

Deutsche Reichsbahn
Erfurt 5 721 X

BR 5 721 X
Rev. 4.10.36

LbP 9,30 m

Ladegew 15 000kg
Tragl 17 500kg

Erfurt 5 721 X

→ 4,30 m ←

BR 5 721 X
Rev. 4.10.36

















hubner
1014 Basaltschotter
Korngröße nach EN 12620



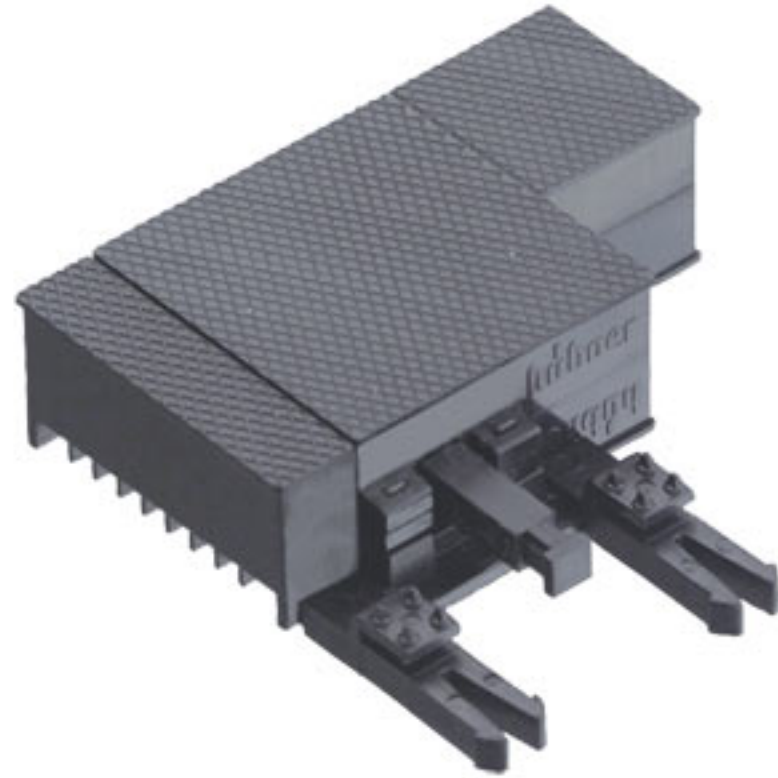





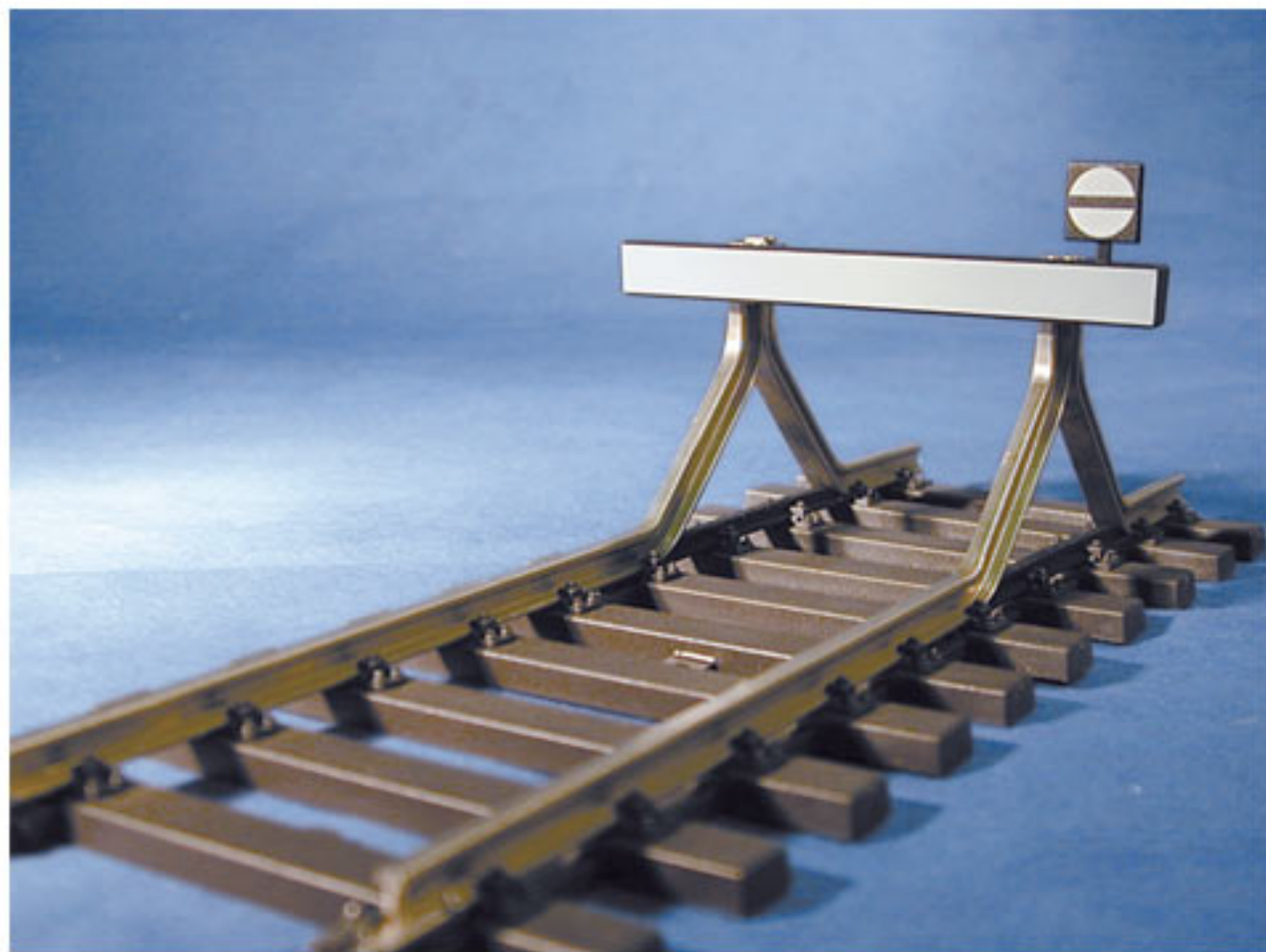







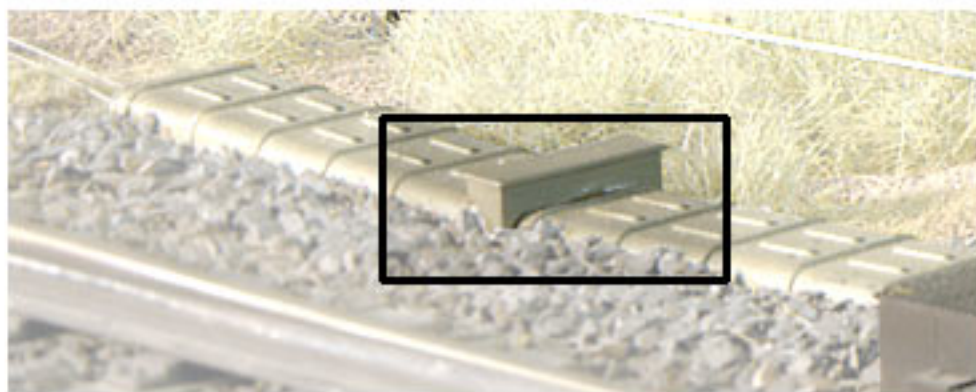











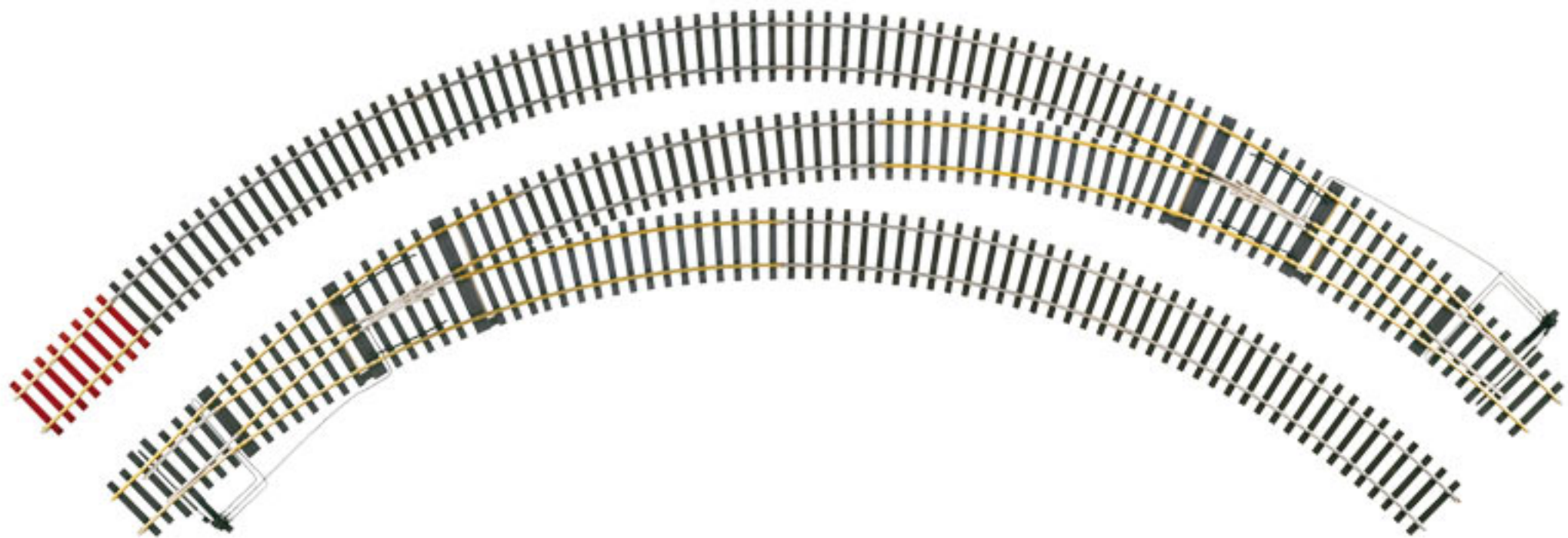

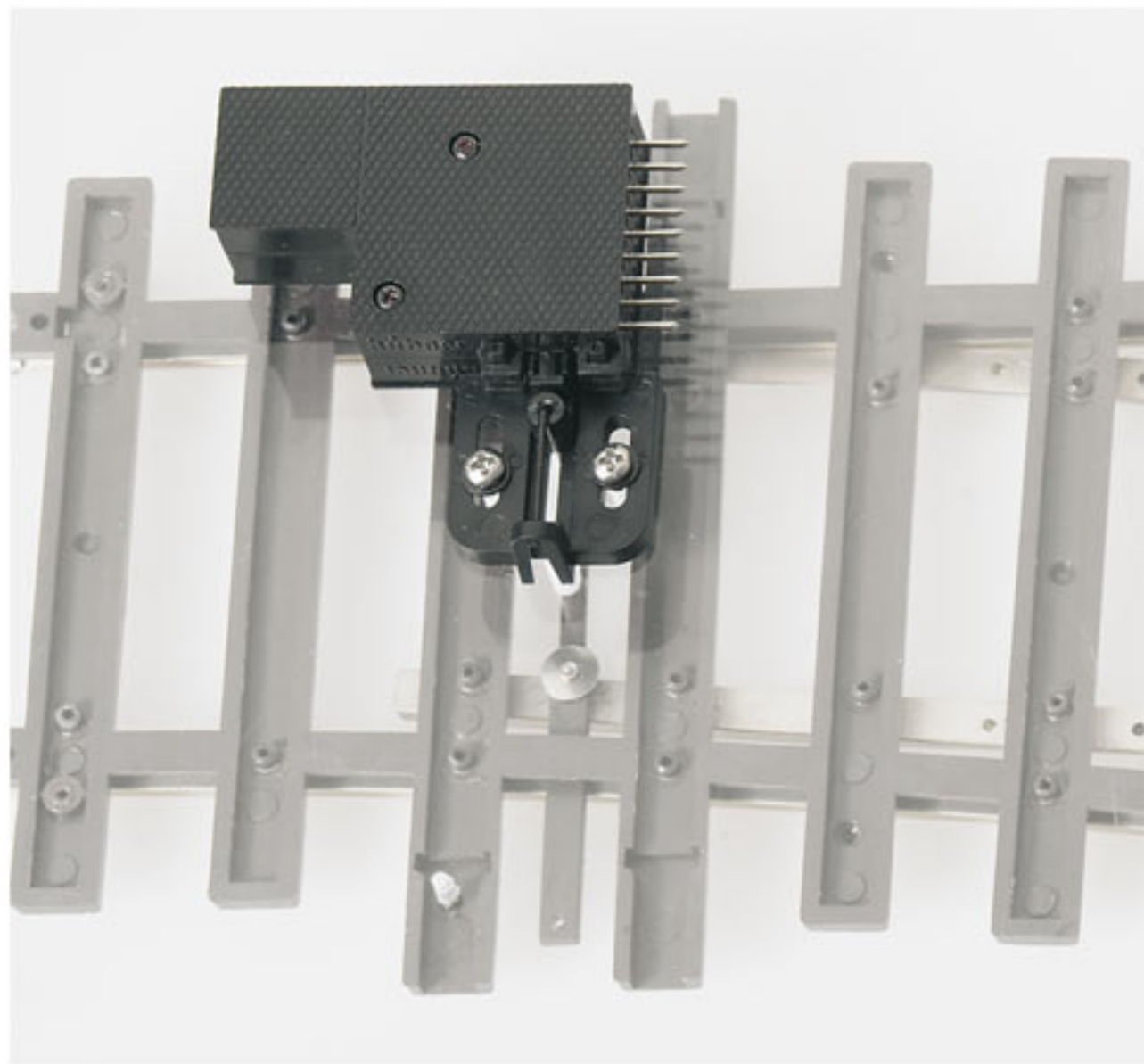

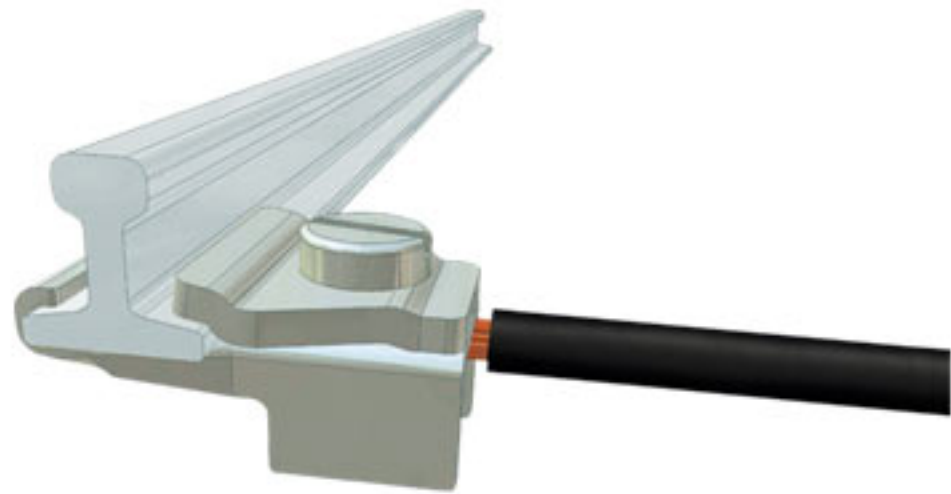





















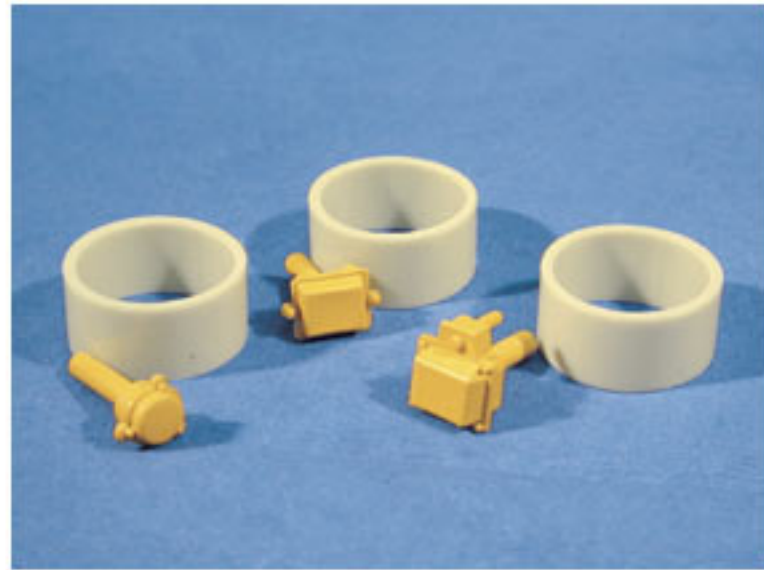







hübner

ENERGETIK-PAK GmbH

4022

echte Steinkohle, Körnung 3-8 mm
ca. 920 Gramm



hübner

REINAKTIVTECHNIK GmbH

4023

echte Steinkohle, Körnung 0,5-1 mm
ca. 920 Gramm



hübner
FEINMERKTECHNIK GMBH
4024 echter Steinkohlengries ca. 900 Gramm
Körnung 0,1-0,3 mm

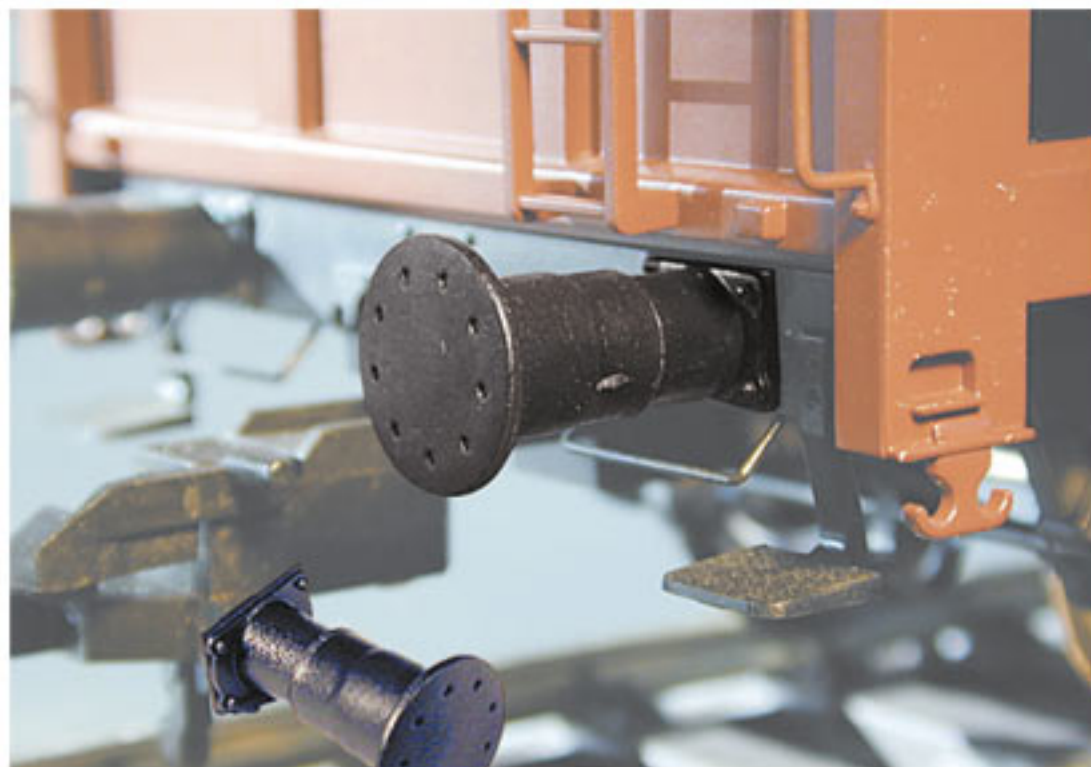

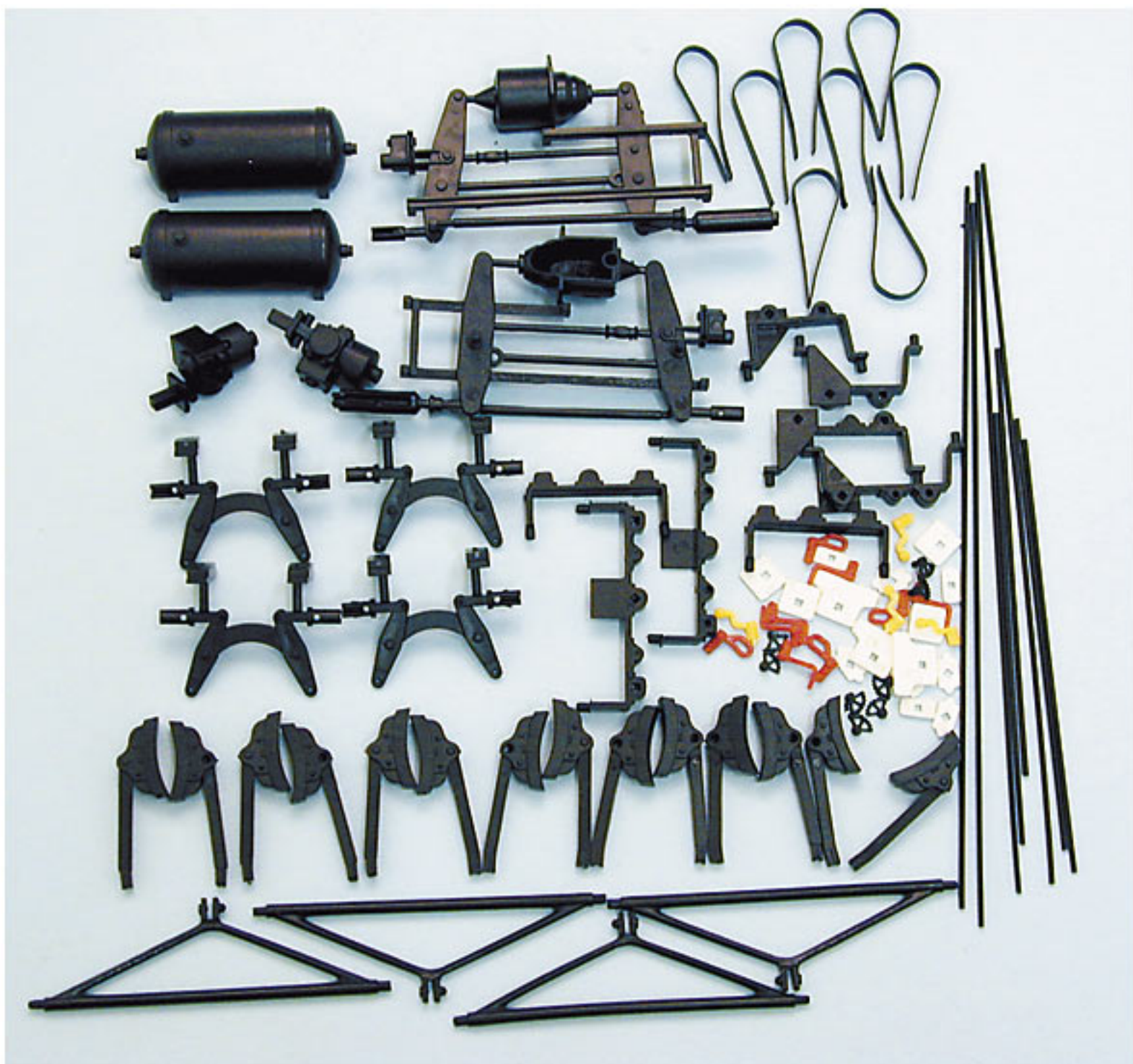



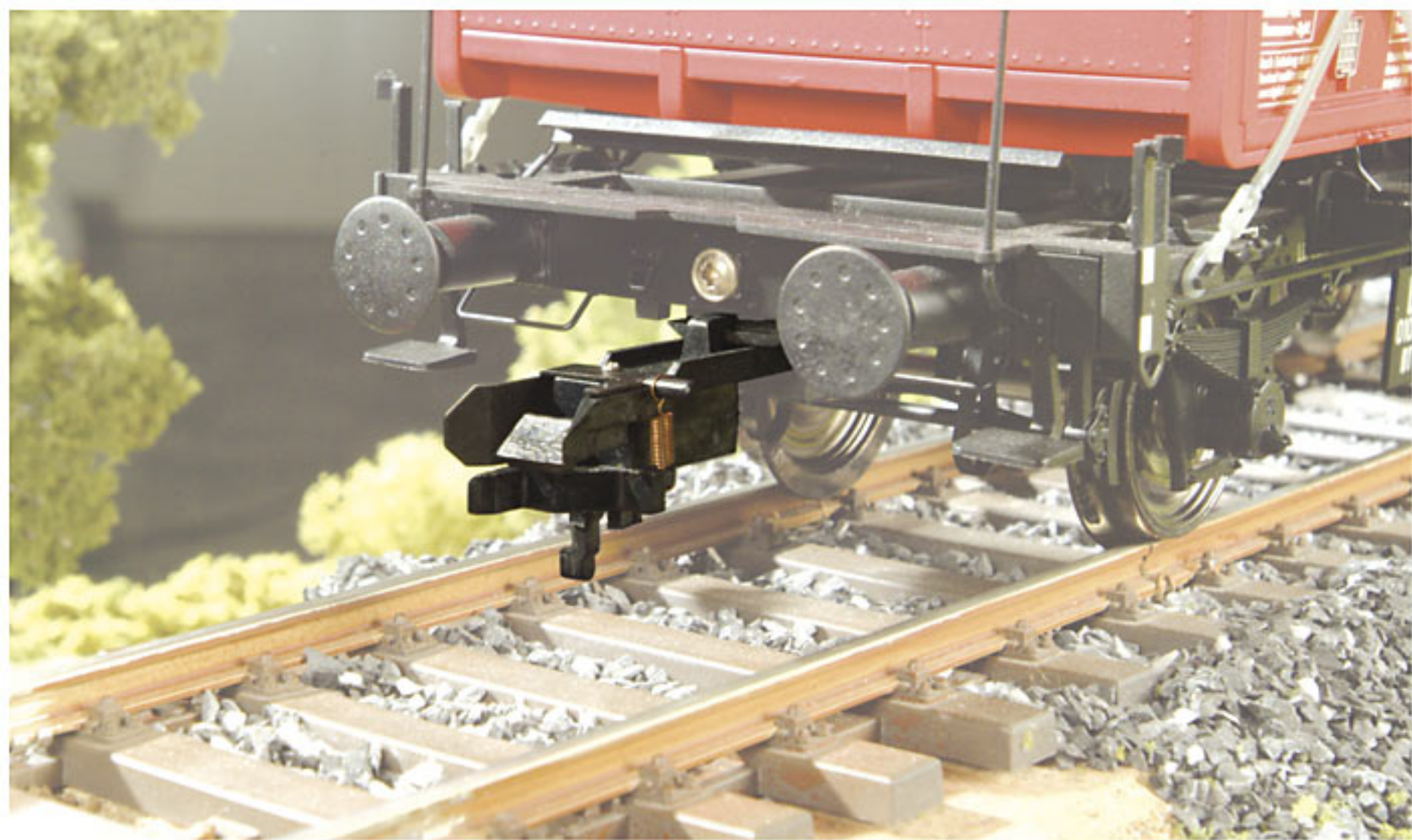

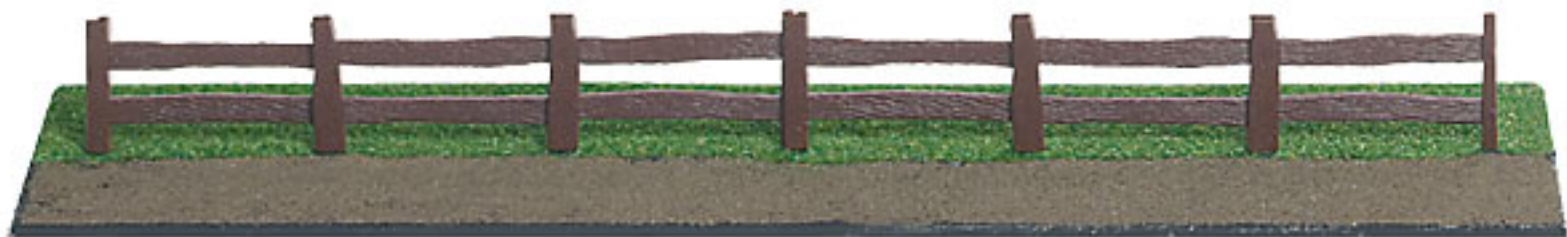





hübner

FEINWIRKTECHNIK GMBH

4055

echter Koks, Körnung 3-6 mm
ca. 670 Gramm

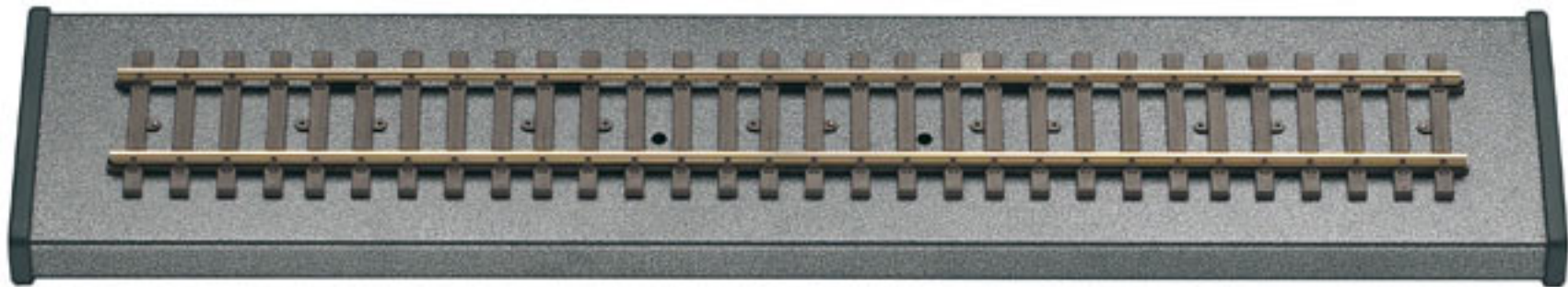

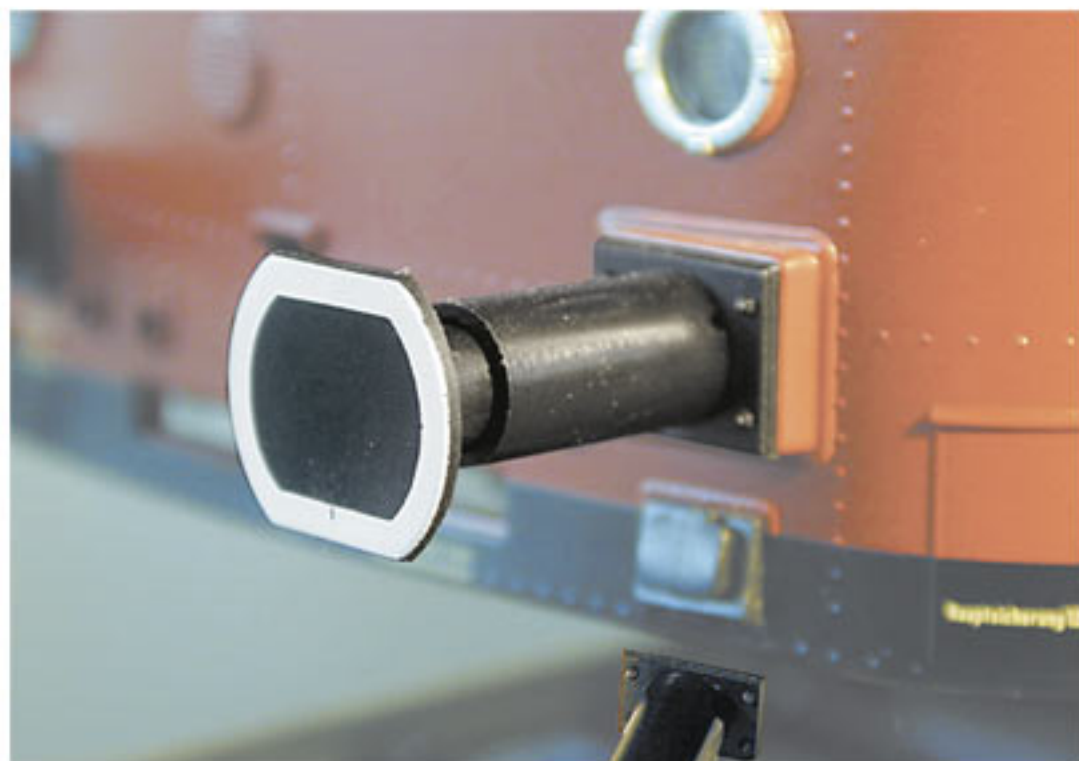

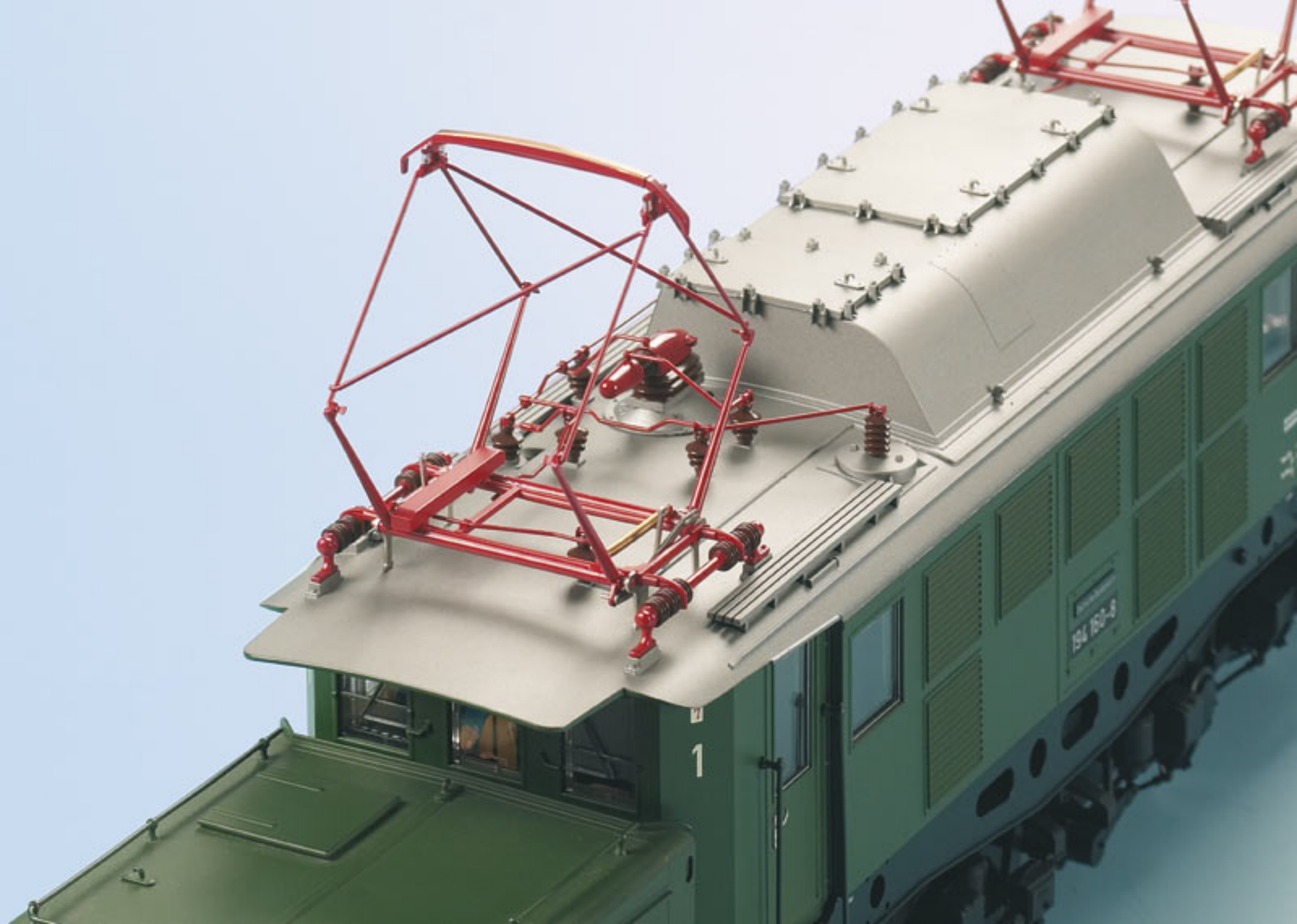



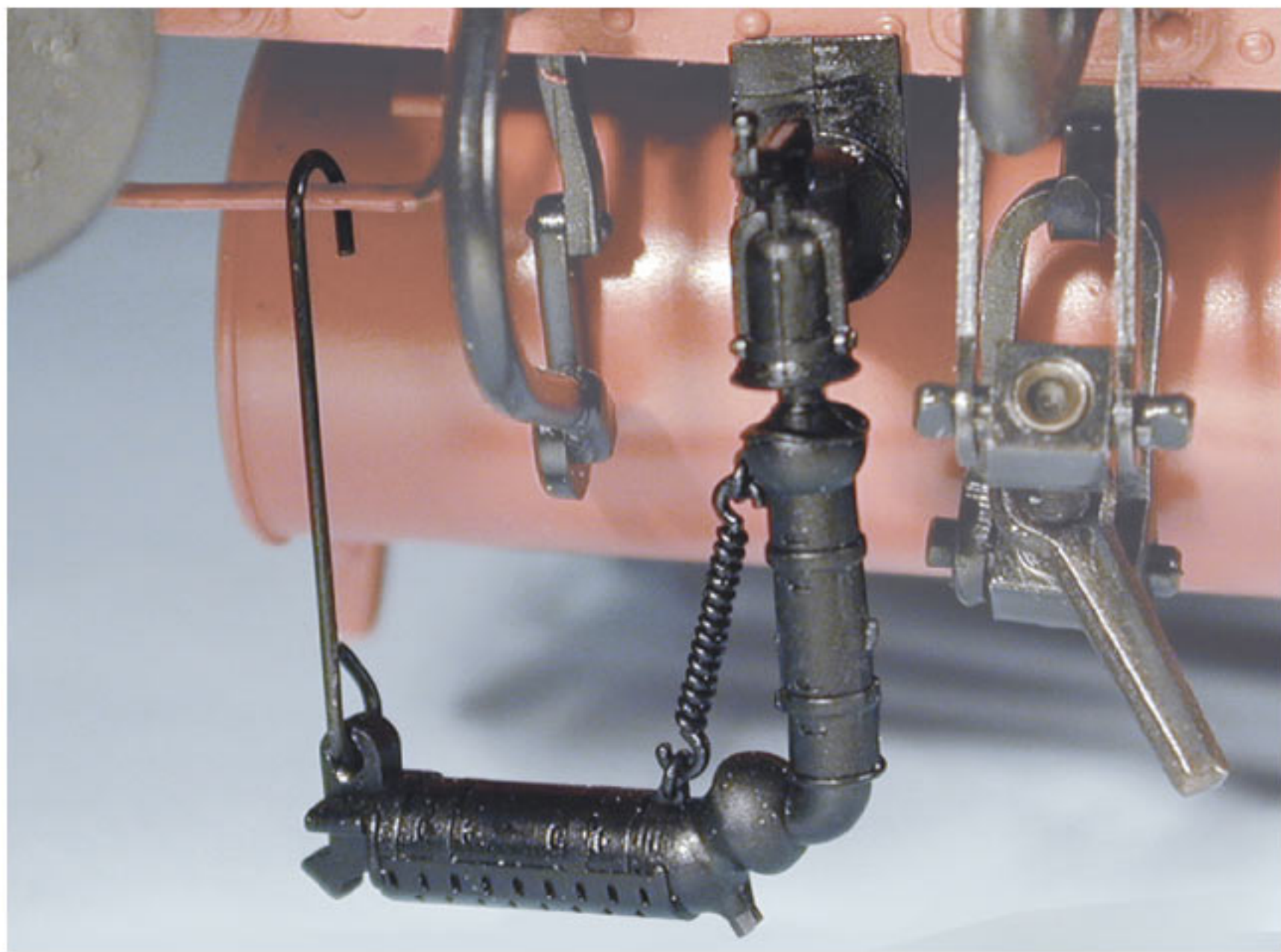





























fährer

hübner

Art.-Nr. 7011
Radkappen 24 Stk.
Wheel boss cap
24 pc.





























